

# Data Sheet



Article number: 339706640000

Description: Multibeam 6 Coupling 706.64.0000  
Aluminium relieved & set screw hubs

## Measures

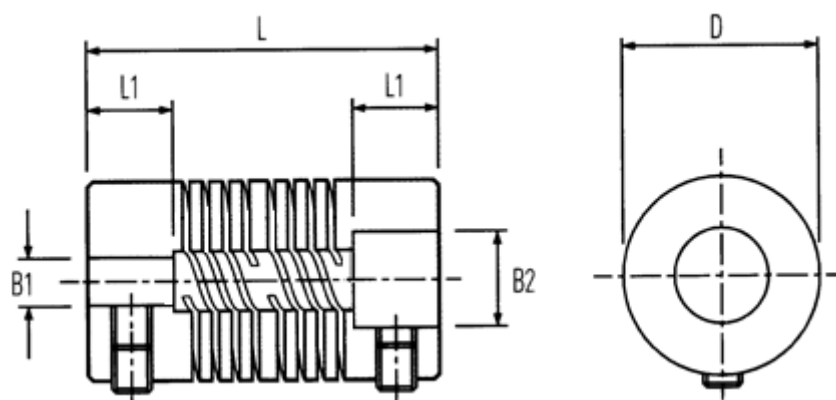

B1: Pre-drilled	= 12.0
B2: Pre-drilled	= 25.00
D	= 63.5
L	= 150.0
L1	= 38.0
Max angular displacement	= 1.00
Max B1 & B2	= 38.00
Max parallel displacement	= 7

Peak Torque NM	= 75.00
Set Screw	= M8